

**ARTEMOBILI**  
móveis com encaixe perfeito

## Nicho 1 porta

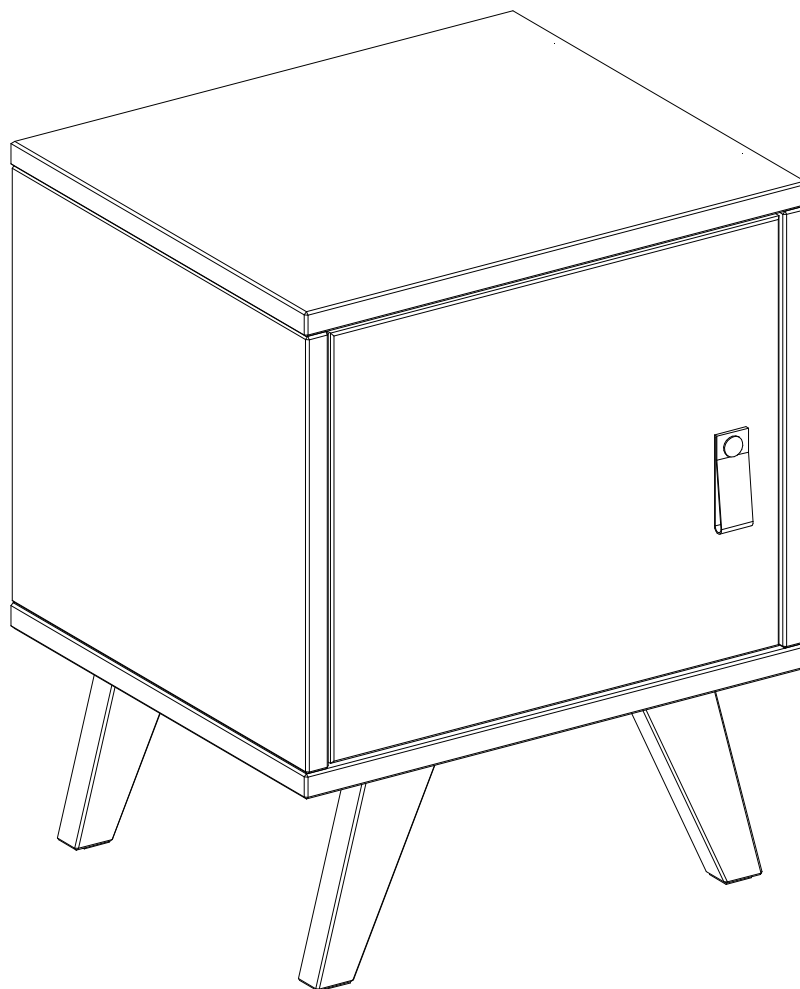

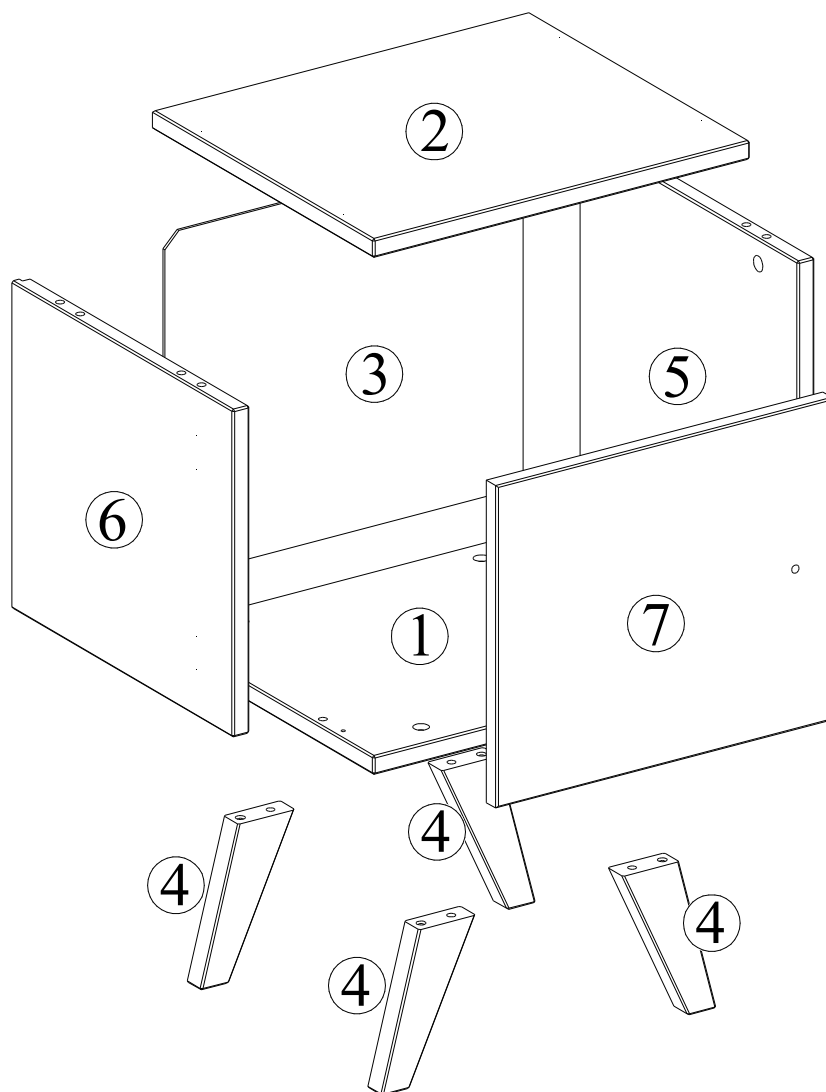

- 1 - 1x 400 x 350 x 18
- 2 - 1x 400 x 350 x 18
- 3 - 1x 380 x 332 x 3
- 4 - 4x 171 x 60 x 24
- 5 - 1x 350 x 314 x 18
- 6 - 1x 350 x 314 x 18
- 7 - 1x 357 x 309 x 18

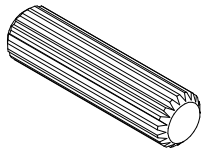
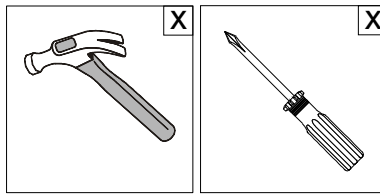

A-12x

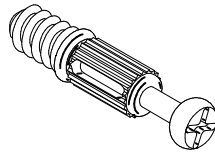

B-4x

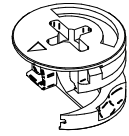

C-4x

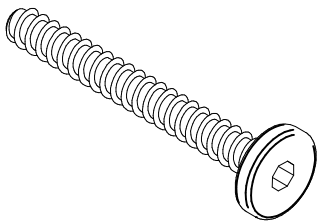

D-4x

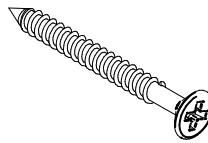

E-4x



F-8x

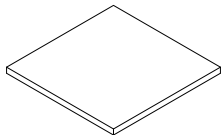

G-4x

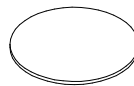

H-4x

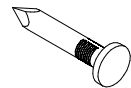

I-16x

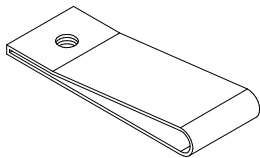

J-1x

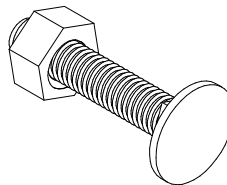

K-1x

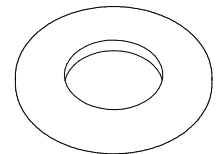

L-1x

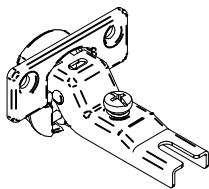

M-2x

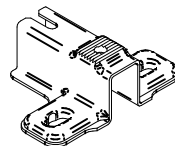

N-2x

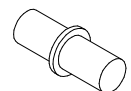

O-1x

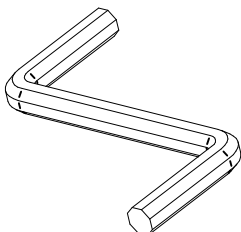

P-1x

**1**

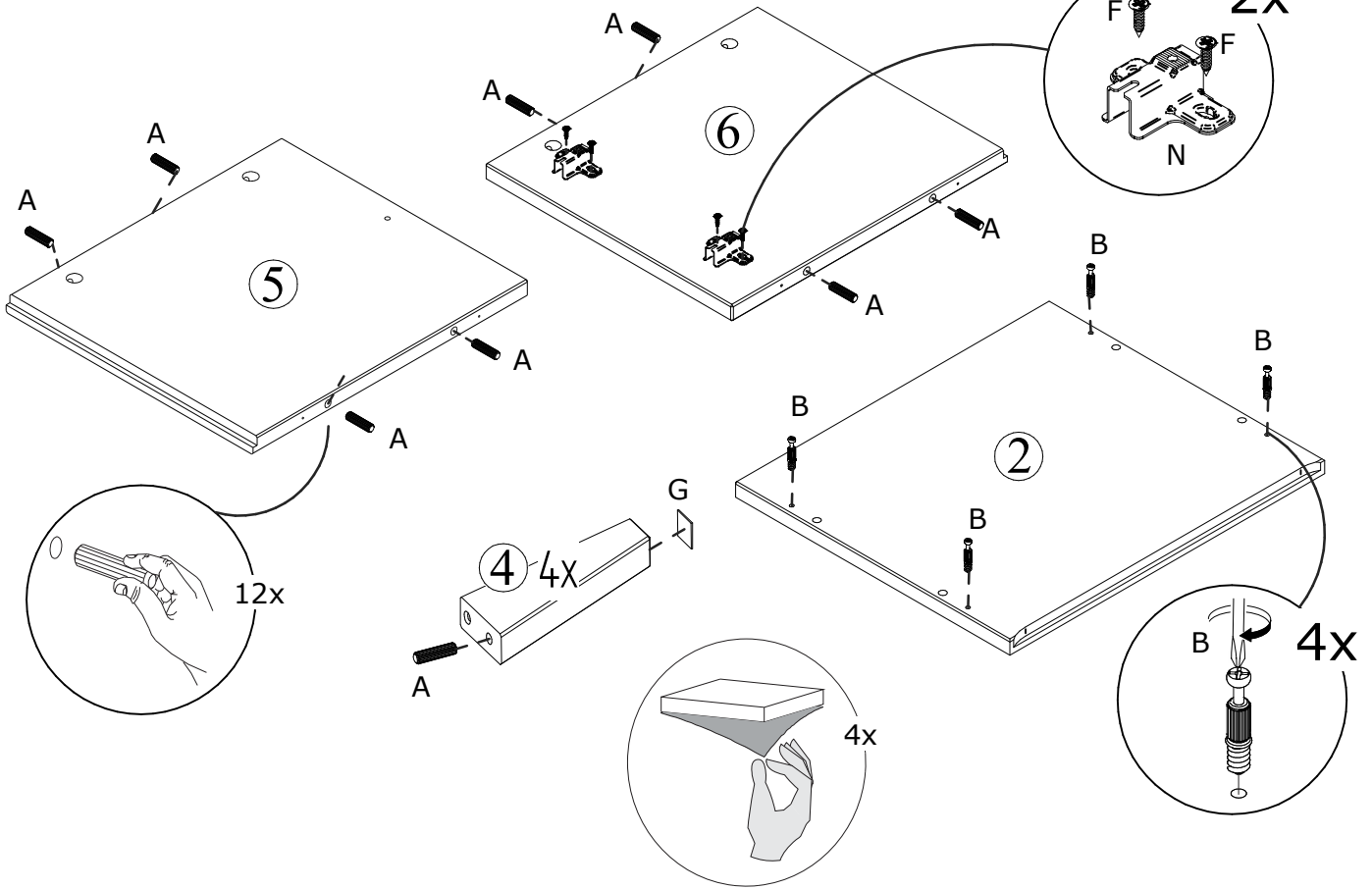
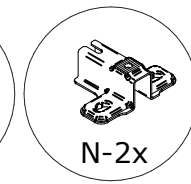
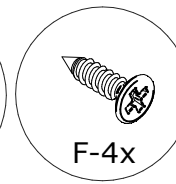
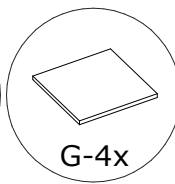
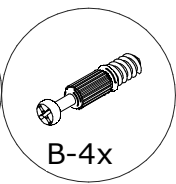
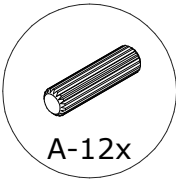

**2**

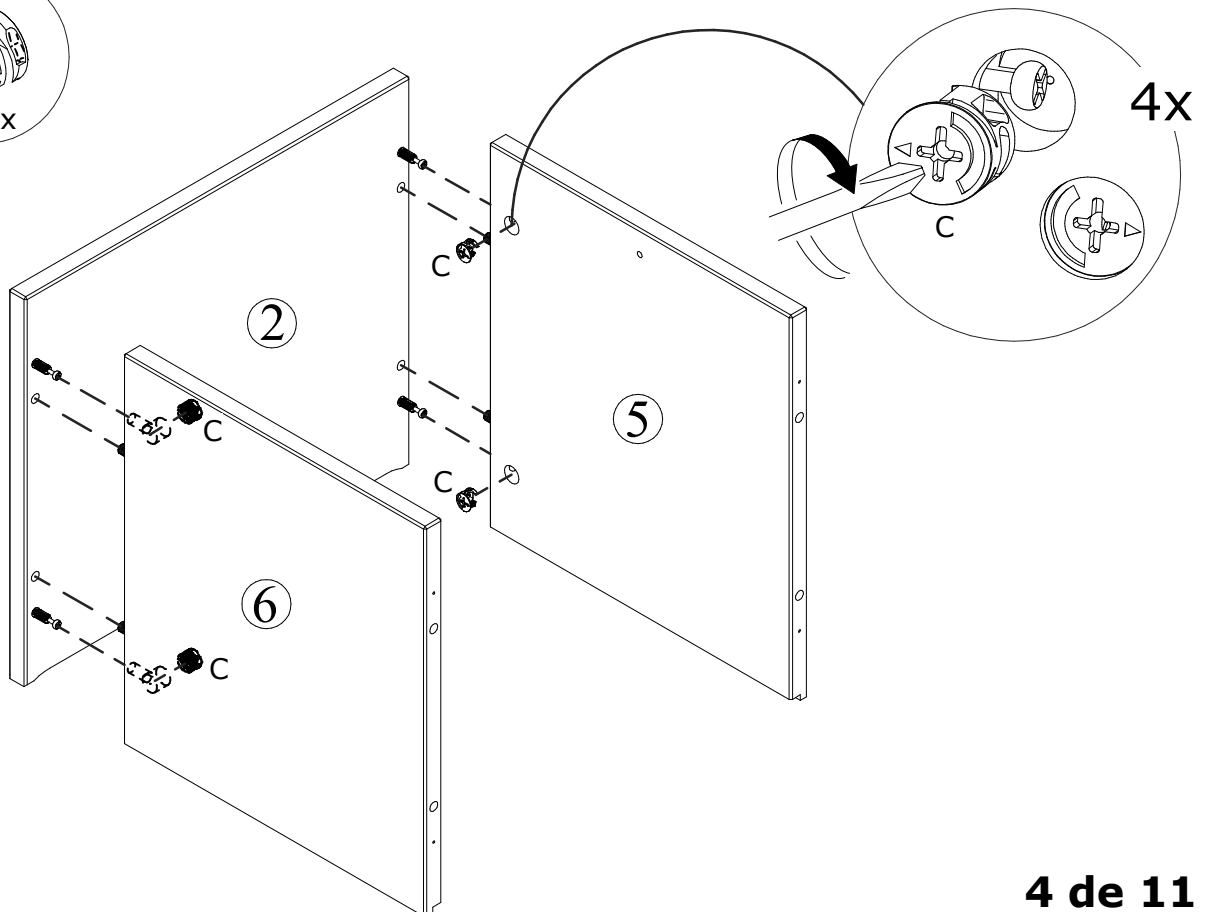
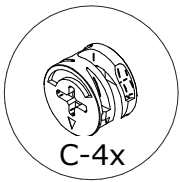

**3**

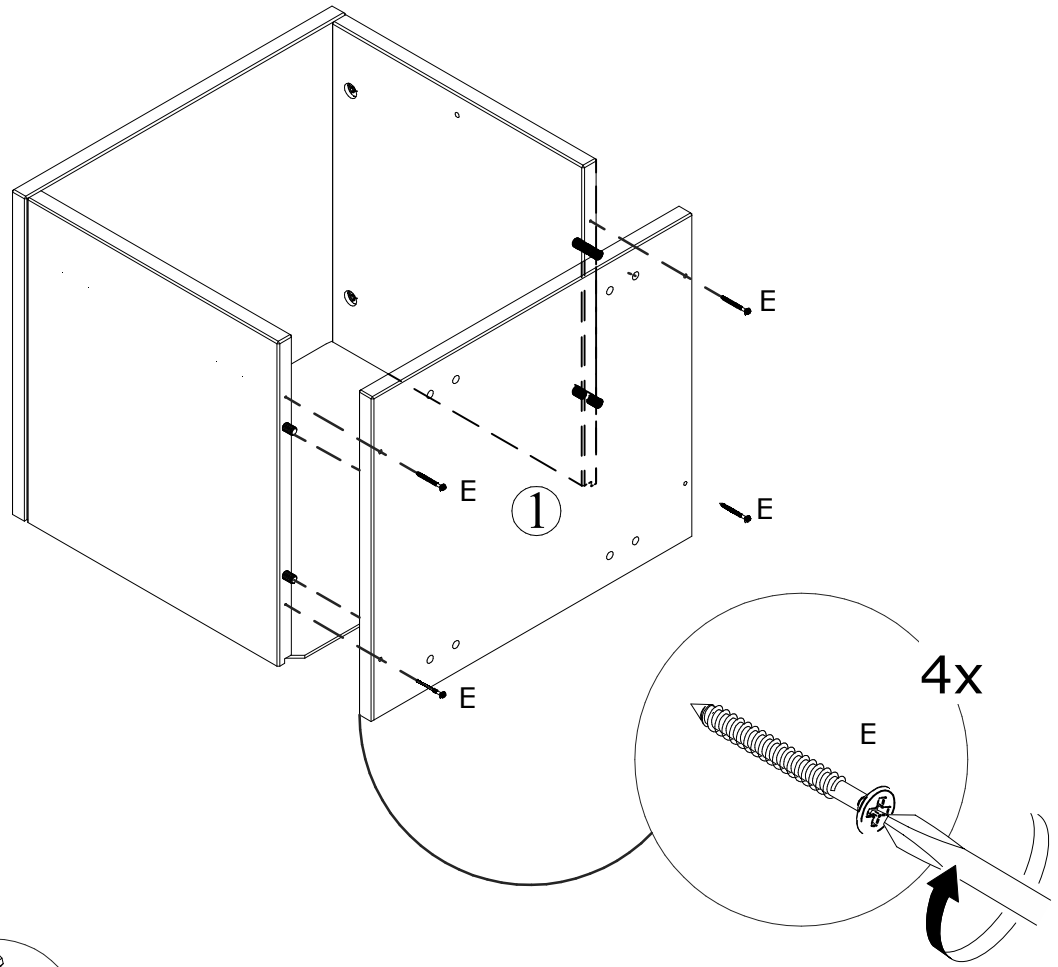
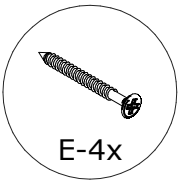

**4**

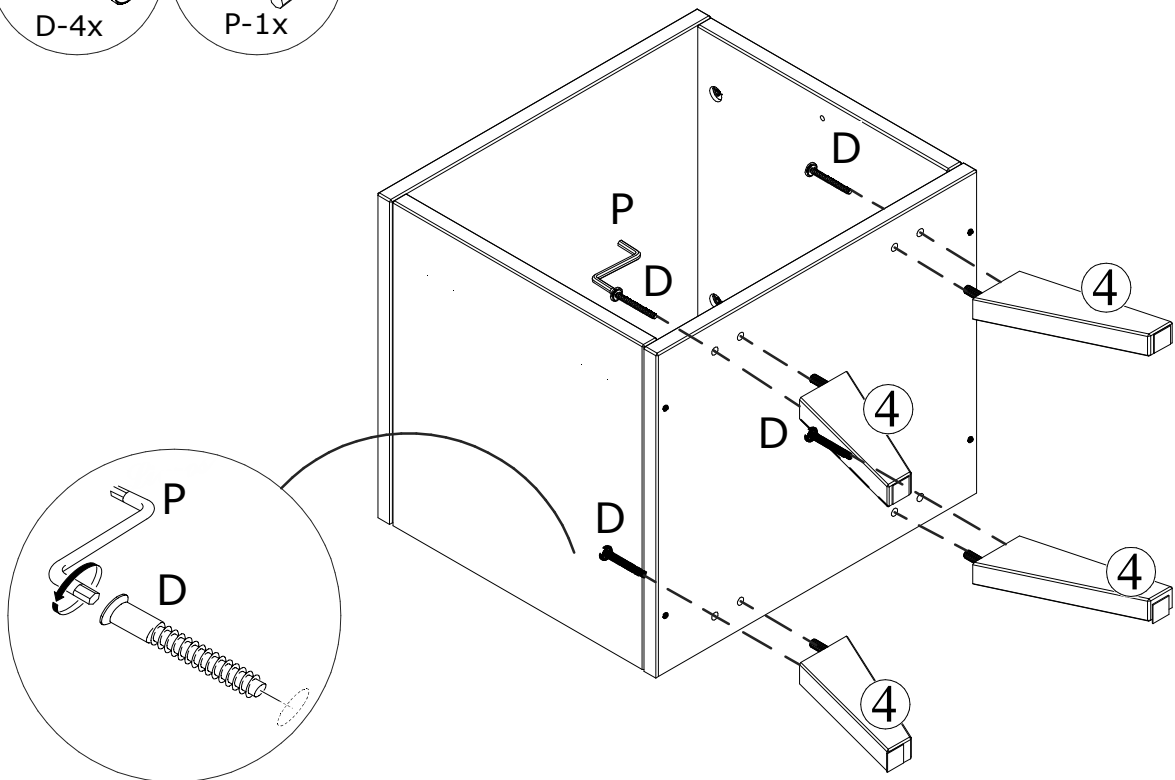
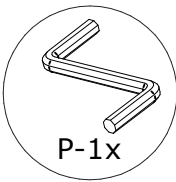
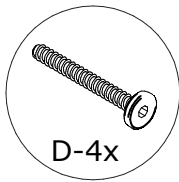

**5**

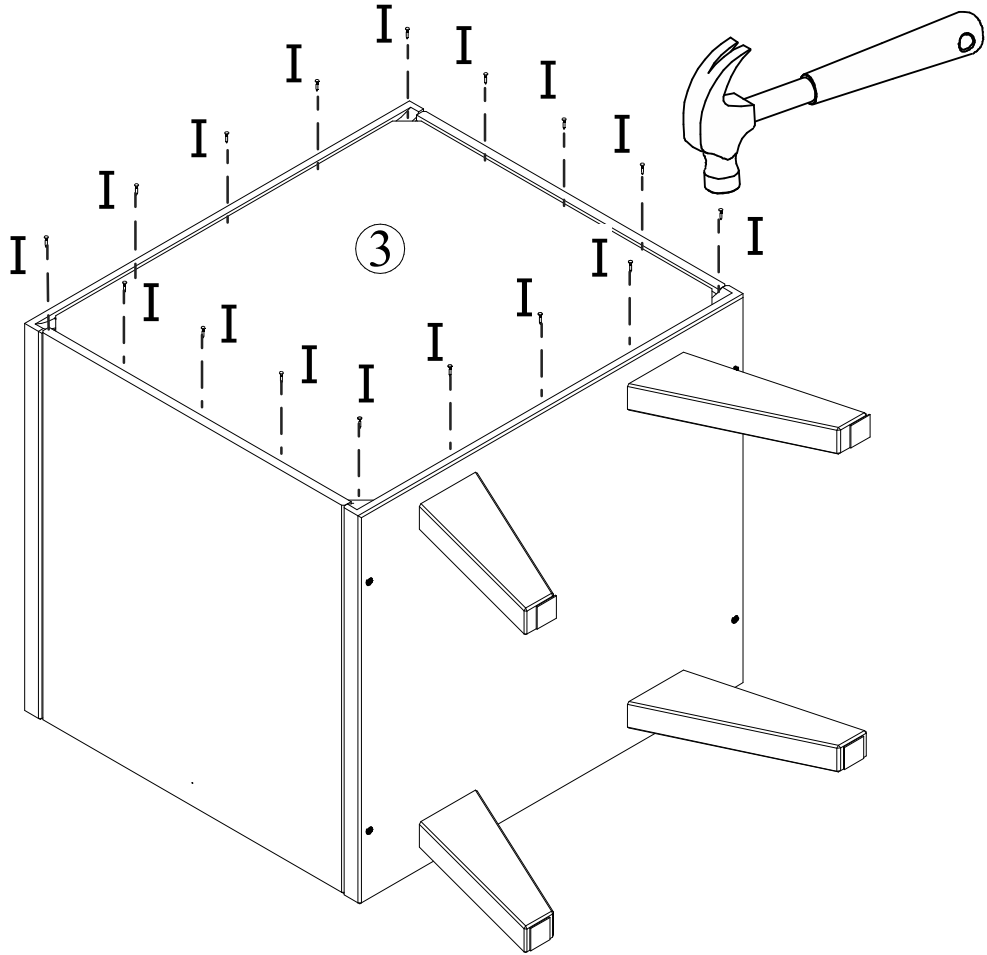
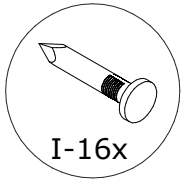

**6**

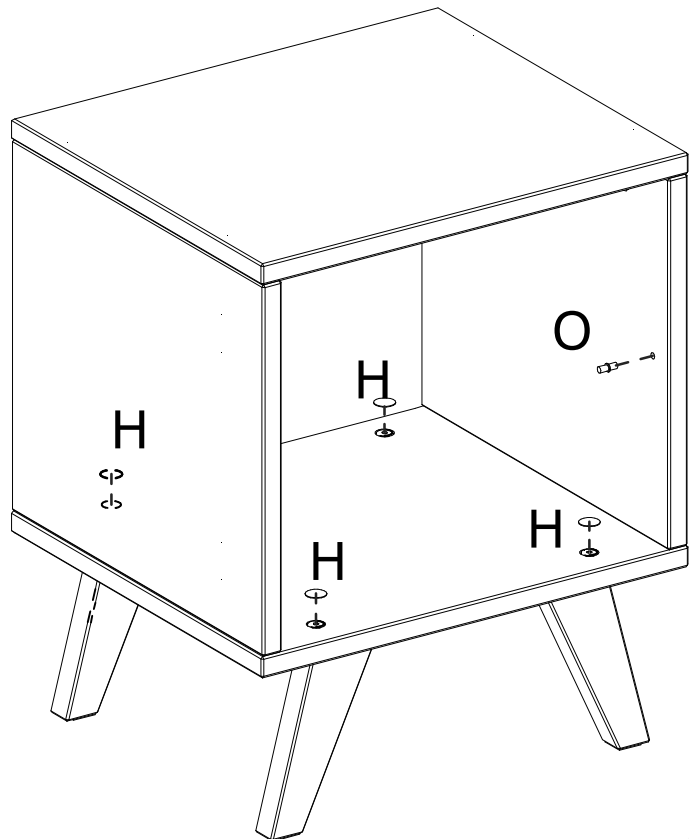
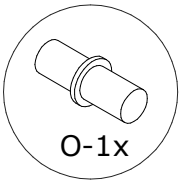
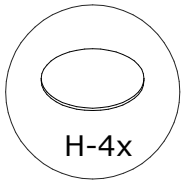

**7**

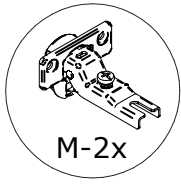

M-2x



F-4x

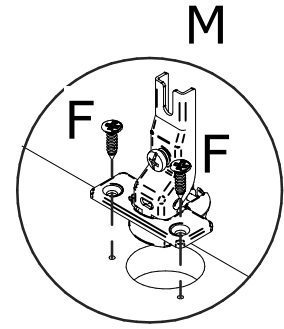
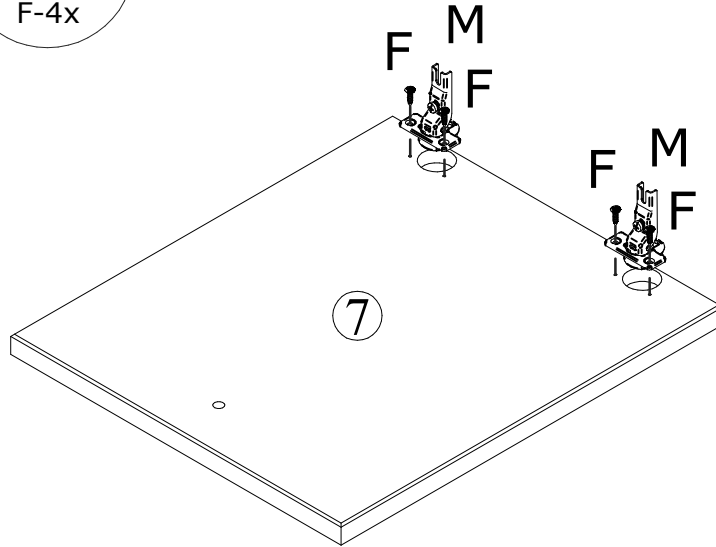

**8**

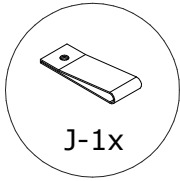

J-1x

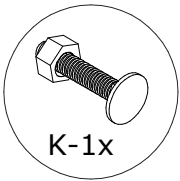

K-1x

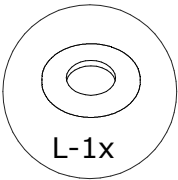

L-1x

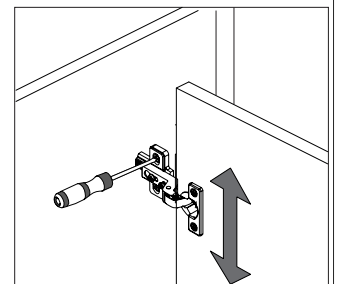
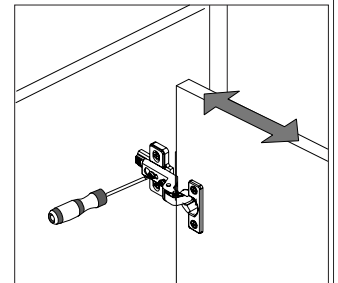
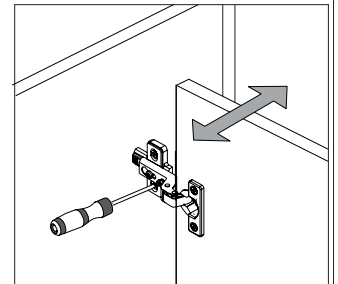
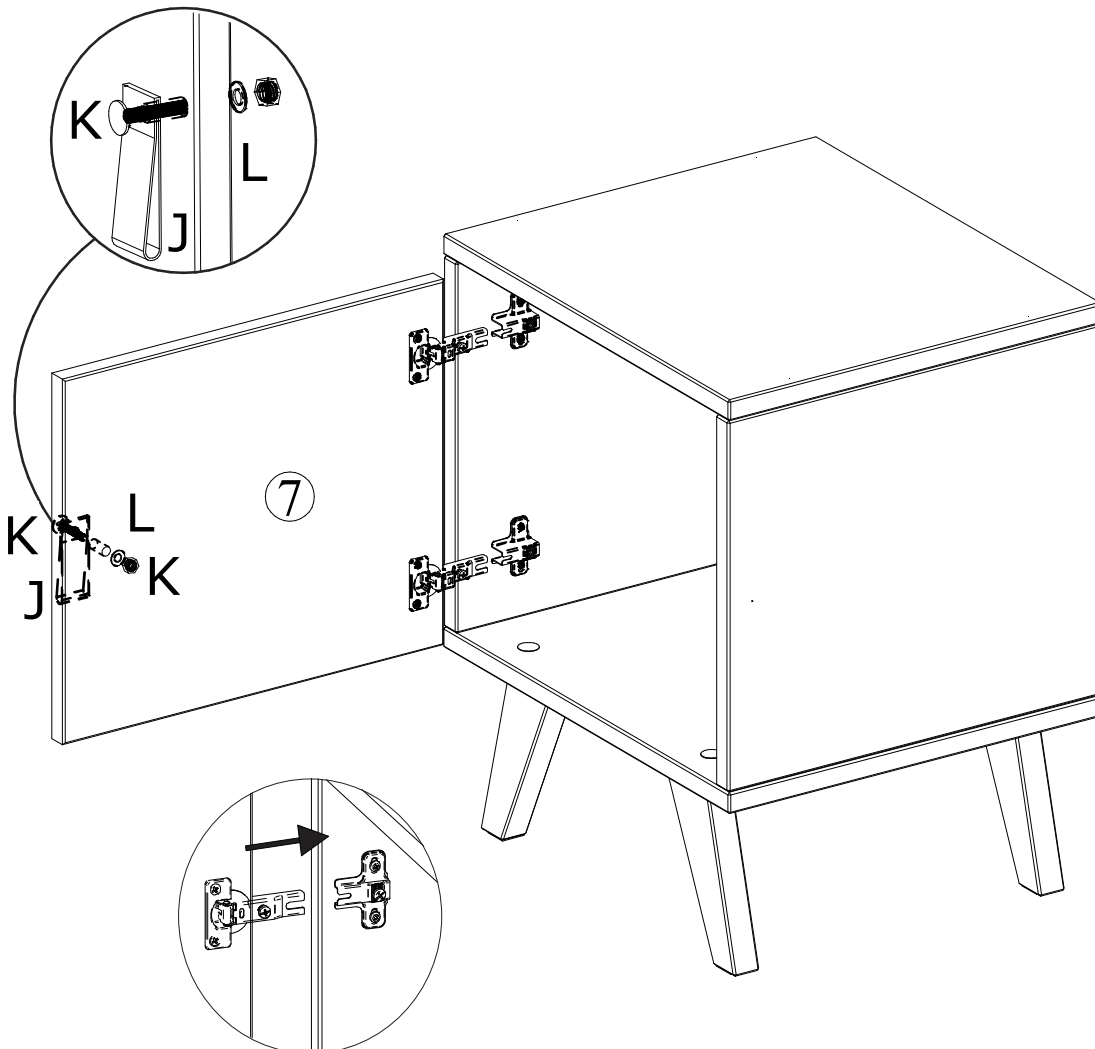

# CUIDADOS COM O MÓVEL

Para limpeza e conservação deste produto, use apenas um pano macio, umedecido com água e sabão neutro (sem amônia).

Não use álcool, detergentes, abrasivos, etc...

Não deixe este produto em contato com o sol, fonte de calor ou ambiente com muito pó.

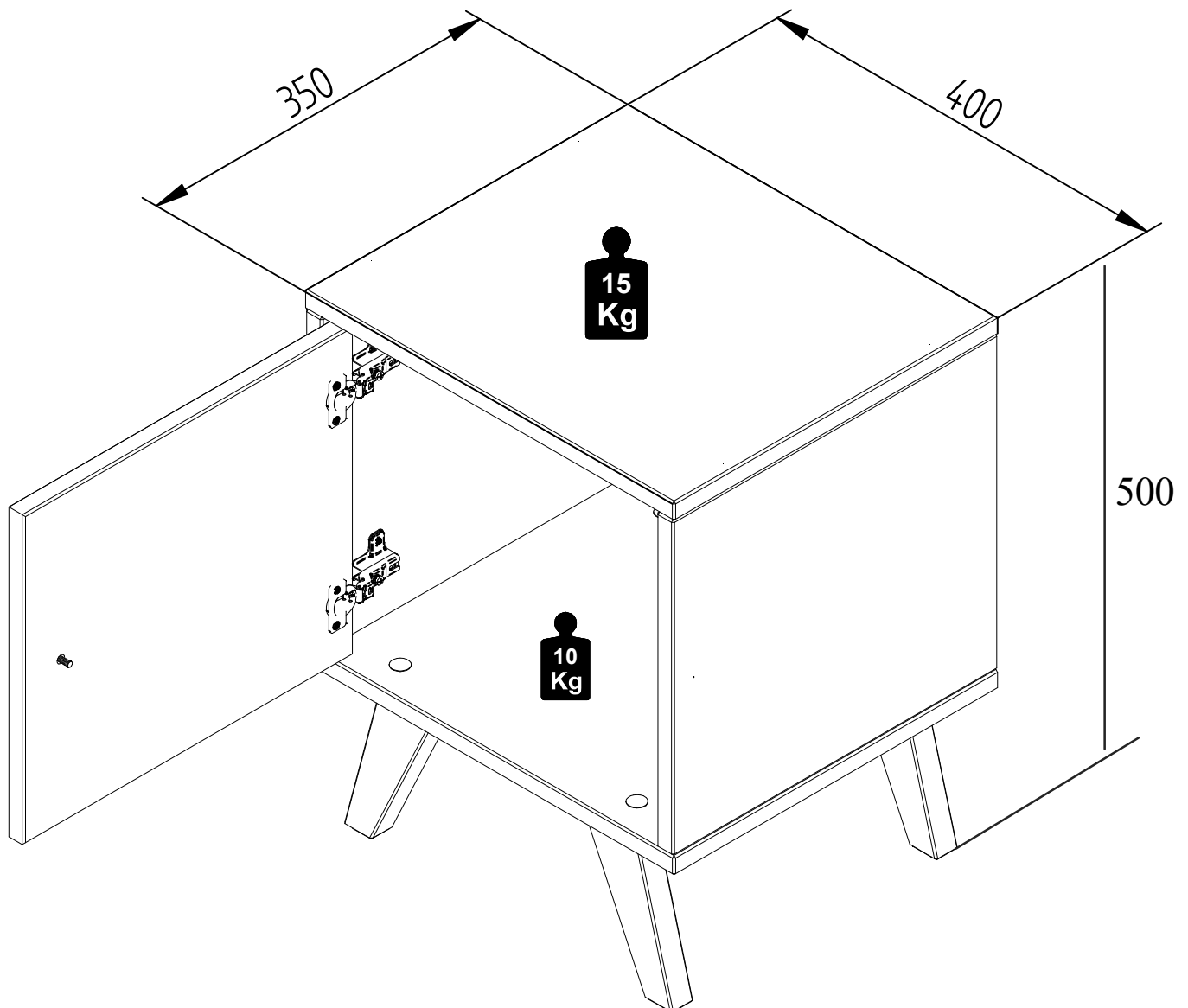



## Certificado de garantia

### **Nicho Auxiliar 1 porta**

Com o intuito de garantir a sua satisfação e confirmar o nosso compromisso com a qualidade, queremos que leia atentamente nossas recomendações para o cuidado do seu móvel.

1. Proteja-o da incidência direta da luz solar.
2. Evite coloca-lo próximo de estufas ou saídas de ar condicionado.
3. Não deixe em lugar úmido e ambientes com muito pó.
4. Evite objetos pontiagudos sobre a superfície.
5. Para limpeza deste produto, use apenas um pano macio, umedecido com água e sabão neutro.
6. Não use álcool, detergentes, abrasivos, etc...
7. A montagem deverá obedecer as instruções do manual, a montagem efetuada de maneira incorreta acarreta na perda de garantia.
8. Em caso de mudança de endereço possíveis avarias no transporte perderão a garantia.
9. Aperte os parafusos periodicamente.

**IMPORTANTE:** todas não conformidades deverão ser apontadas no momento do recebimento do produto.

### **Prazo de garantia:**

Será de seis (06) meses a garantia do móvel por defeitos de fabricação, ressalvadas condições normais de uso e as demais condições do presente certificado, contados da data da emissão da nota fiscal.

**\*\* O certificado de garantia só será válido se apresentado juntamente com a nota fiscal.**

## Certificado de garantia

Con la intención de garantizar su satisfacción y de acuerdo con nuestro compromiso de calidad, queremos que el Sr, Sra, lean atentamente nuestras instrucciones con el cuidado de su mueble.

1. Protégalo de la luz directa del sol.
2. Evite colocarlo próximo de estufas o salidas de aire acondicionado.
3. No deje en lugar húmedo y o ambientes con mucho polvo.
4. Evite objetos puntiagudos sobre su superficie.
5. Para la limpieza de este producto, use solamente un paño suave, húmedo con agua y jabón neutro.
6. No use alcohol, detergentes, abrasivos, etc...
7. El montaje tendrá que seguir las instrucciones del manual, de lo contrario llevará a la pérdida de la garantía.
8. En caso de mudanza a otra dirección posibles daño en el transporte perderán la garantía.
9. Aprete los tornillos periódicamente.

IMPORTANTE: todas no conformidades deverão ser anotadas en el momento de recibir el producto.

### **Plazo de garantía:**

Seis meses (06) la garantía do mueble por defectos de fabricación, salvedad condiciones normales de uso y las demás condiciones del presente certificado, contados a partir de las fecha de emisión de la factura correspondiente.

**\*\*El Certificado de garantía solo será válido presentándolo junto con la factura.**

## **CUIDADOS CON EL MUEBLE**

Para mejor limpieza y conservación del producto, use solamente un paño suave, húmedo con agua y jabão neutro (sin amonia).

No use alcohol, detergentes, abrasivos, etc...

No deje este producto en contacto el sol, lugares de mucho calor y ambiente con mucho polvo.

## Certificate of Guarantee

In order to ensure your satisfaction and confirm our commitment with quality, we want you to carefully read our recommendations for the care of your furniture.

1. Protect it from direct sunlight.
2. Avoid placing it near greenhouses or air conditioning vents.
3. Do not leave in a humid place and environments with a lot of dust.
4. Avoid sharp objects on the surface.
5. To clean this product, use only a soft cloth, moistened with mild soap and water.
6. Do not use alcohol, detergents, abrasives, etc...
7. The assembly must obey the instructions in the manual, the incorrectly assemble results in the loss of warranty.
8. In case of change of address, possible damage in transport will lose the warranty.
9. Tighten the screws periodically.

IMPORTANT: all conformities must be noted at the time of receive the product.

### **Warranty term:**

Six (06) months warranty on the furniture for manufacturing defects, except for the normal conditions of use and the other conditions of this certificate, invoice issuing data.

**\*\*The warranty certificate will be valid if included with an invoice.**

## **TAKE CARE OF YOUR FURNITURE**

To clean and maintain this product, use only a soft cloth, moistened with water and mild soap (without ammonia).

Do not use alcohol, detergents, abrasives, etc ...

Do not leave this product in contact with the sun, heat source or environment with a lot of dust.